

IP43
WATERPROOF

ABSOLUTE ENCODER, THE ORIGINAL
DATA REMAINS AFTER POWER OFF

HIGH PRECISION DIGITAL LINEAR GAGES

**INSPECTION
CERTIFICATE**

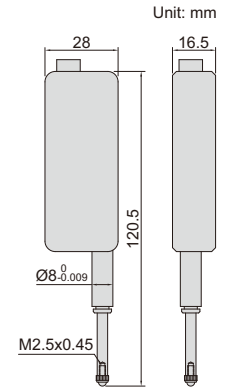

- Scale type: optical grating
- Absolute encoder, the original data remains after power off
- Digital signal output, amplifier is not required
- Repeatability: 0.5µm
- Measuring force: 1.5N
- Dust/waterproof: IP43
- Baud rate: 9600 (can be customized)
- Cable length: 3m (can be customized)

Code	Range	Resolution	Accuracy	Outgoing cable direction	Output signal	Output interface
7130-10	0-12.7mm	0.1µm	1.6µm	horizontal	RS232, TTL level	
7130-10L	0-12.7mm	0.1µm	1.6µm	vertical	RS232, TTL level	
7130-11	0-12.7mm	0.1µm	1.6µm	horizontal	RS232, 232 level	
7130-11L	0-12.7mm	0.1µm	1.6µm	vertical	RS232, 232 level	
7130-12	0-12.7mm	0.1µm	1.6µm	horizontal	RS485	
7130-12L	0-12.7mm	0.1µm	1.6µm	vertical	RS485	
7130-13	0-12.7mm	0.1µm	1.6µm	horizontal	RS232, TTL level	
7130-13L	0-12.7mm	0.1µm	1.6µm	vertical	RS232, TTL level	
7130-14	0-12.7mm	0.1µm	1.6µm	horizontal	RS232, 232 level	
7130-14L	0-12.7mm	0.1µm	1.6µm	vertical	RS232, 232 level	

**JEWELLED
BEARING**

**INSPECTION
CERTIFICATE**
TRACEABLE TO NIST

PRECISION DIAL INDICATORS

- Graduation: 0.001mm
- Jeweled bearing
- Supplied with limit pointers and bezel clamp
- Optional accessory: backs (page 167~168), contact points (page 164~166)



2313-1A

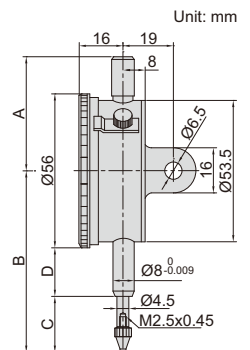

Code	Range	Accuracy	Hysteresis	Range/rev	Dial reading	Remark	A	B	C	D
2313-1FA *	1mm	5µm	2µm	0.2mm	0-100-0	flat back	45	62.5	19.5	15
2313-2FA *	2mm	6µm	2.5µm	0.2mm	0-100-0	flat back	45	62.5	19.5	15
2313-1A *	1mm	5µm	2µm	0.2mm	0-100-0	lug back	45	62.5	19.5	15
2313-2A *	2mm	6µm	2.5µm	0.2mm	0-100-0	lug back	45	62.5	19.5	15

* Supplied with manufacturer inspection certificate traceable to NIST USA

COMPACT DIAL INDICATORS

JEWELLED BEARING

INSPECTION CERTIFICATE
TRACEABLE TO NIST

- Meet DIN878
- Jeweled bearing
- Supplied with limit pointers and bezel clamp
- Optional accessory: backs (page 167~168), contact points (page 164~166)



2311-5

(mm)

Code	Range	Graduation	Accuracy	Hysteresis	Range/rev	Dial reading	Remark	B	D
2311-3F *	3mm	0.01mm	12µm	3µm	0.5mm	0-50	flat back	46	10.5
2311-5F *	5mm	0.01mm	14µm	3µm	0.5mm	0-50	flat back	48	12.5
2311-3 *	3mm	0.01mm	12µm	3µm	0.5mm	0-50	lug back	46	10.5
2311-5 *	5mm	0.01mm	14µm	3µm	0.5mm	0-50	lug back	48	12.5

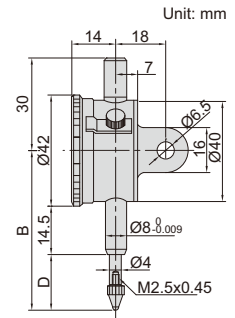

*Supplied with manufacturer inspection certificate traceable to NIST USA

DIAL INDICATORS (BASIC TYPE)

- Meet DIN878
- Jeweled bearing
- Supplied with limit hands and bezel clamp
- Packed in carton box
- Optional accessory: backs (page 167~168), contact points (page 164~166)



2301-10

INSPECTION CERTIFICATE
TRACEABLE TO NIST

Code	Range	Graduation	Accuracy	Hysteresis	Range/rev	Dial reading	Remark
2301-10F *	10mm	0.01mm	17µm	3µm	1mm	0-100	flat back
2301-10 *	10mm	0.01mm	17µm	3µm	1mm	0-100	lug back with spare flat back

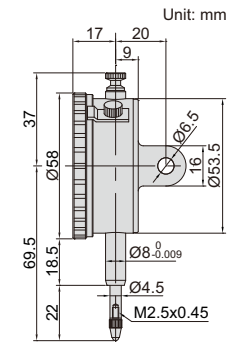

*Supplied with manufacturer inspection certificate traceable to NIST USA

DIAL INDICATORS (STANDARD TYPE)

- Meet DIN878
- Jeweled bearing
- Supplied with limit pointers and bezel clamp
- Optional accessory: backs (page 167~168), contact points (page 164~166)



2308-10A

JEWELLED BEARING

INSPECTION CERTIFICATE
TRACEABLE TO NIST

Code	Range	Graduation	Accuracy	Hysteresis	Range/rev	Dial reading	Remark
2308-3FA *	3mm	0.01mm	12µm	3µm	1mm	0-100	flat back
2308-5FA *	5mm	0.01mm	14µm	3µm	1mm	0-100	flat back
2308-10FA *	10mm	0.01mm	17µm	3µm	1mm	0-100	flat back
2308-3A *	3mm	0.01mm	12µm	3µm	1mm	0-100	lug back
2308-5A *	5mm	0.01mm	14µm	3µm	1mm	0-100	lug back
2308-10A *	10mm	0.01mm	17µm	3µm	1mm	0-100	lug back

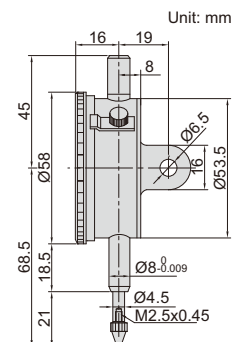

*Supplied with manufacturer inspection certificate traceable to NIST USA

JEWELLED BEARING

INSPECTION CERTIFICATE
TRACEABLE TO NIST

REVERSE READING DIAL INDICATORS

- Meet DIN878
- Suitable for depth and step measurements
- Jeweled bearing
- Supplied with limit pointers and bezel clamp
- Optional accessory: backs (page 167~168), contact points (page 164~166)



2801-10

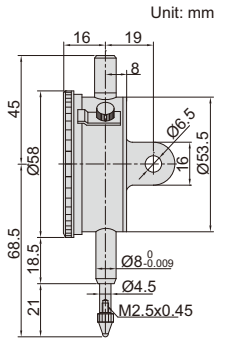

Code	Range	Graduation	Accuracy	Hysteresis	Range/rev	Dial reading	Remark
2801-10F *	10mm	0.01mm	17µm	3µm	1mm	100-0	flat back
2801-10 *	10mm	0.01mm	17µm	3µm	1mm	100-0	lug back

* Supplied with manufacturer inspection certificate traceable to NIST USA

SHOCK PROOF

JEWELLED BEARING

INSPECTION CERTIFICATE
TRACEABLE TO NIST

SHOCKPROOF DIAL INDICATORS

- Meet DIN878
- Shockproof
- Jeweled bearing
- Supplied with limit pointers and bezel clamp
- Optional accessory: backs (page 167~168), contact points (page 164~166)



2314-10A

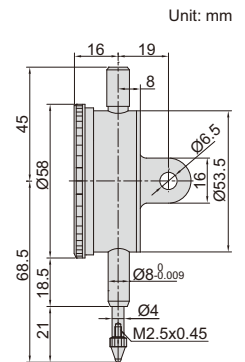

Code	Range	Graduation	Accuracy	Hysteresis	Range/rev	Dial reading	Remark
2314-3FA *	3mm	0.01mm	12µm	3µm	1mm	0-100	flat back
2314-5FA *	5mm	0.01mm	14µm	3µm	1mm	0-100	flat back
2314-10FA *	10mm	0.01mm	17µm	3µm	1mm	0-100	flat back
2314-3A *	3mm	0.01mm	12µm	3µm	1mm	0-100	lug back
2314-5A *	5mm	0.01mm	14µm	3µm	1mm	0-100	lug back
2314-10A *	10mm	0.01mm	17µm	3µm	1mm	0-100	lug back

* Supplied with manufacturer inspection certificate traceable to NIST USA

INSPECTION CERTIFICATE
TRACEABLE TO NIST

INCH DIAL INDICATORS

- Meet ASME B89.1.10M-2001
- With lug back
- Supplied with limit pointers and bezel clamp



2307-1

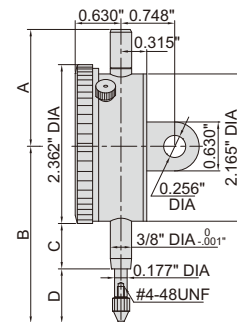

Code	Range	Graduation	Accuracy		Range/rev	Dial reading
			First 2.5 rev	Overall		
2307-025 *	0.25"	0.001"	±0.001"	±0.001"	0.1"	0-100
2307-05 *	0.5"	0.001"	±0.001"	±0.002"	0.1"	0-100
2307-1 *	1"	0.001"	±0.001"	±0.002"	0.1"	0-100
2307-2 *	2"	0.001"	±0.001"	±0.004"	0.1"	0-100
2307-0255 *	0.25"	0.0005"	±0.0005"	±0.0015"	0.05"	0-50
2307-055 *	0.5"	0.0005"	±0.0005"	±0.0015"	0.05"	0-50
2307-105 *	1"	0.0005"	±0.0005"	±0.002"	0.05"	0-50
2307-205 *	2"	0.0005"	±0.0005"	±0.002"	0.05"	0-50

Range	A	B	C	D
0.25"	1.811"	2.953"	0.787"	0.984"
0.5"	1.811"	2.953"	0.787"	0.984"
1"	1.811"	3.346"	0.787"	1.378"
2"	4.370"	5.472"	1.969"	2.323"

* Supplied with manufacturer inspection certificate traceable to NIST

WATERPROOF DIAL INDICATORS

**INSPECTION
CERTIFICATE**
TRACEABLE TO NIST

**IP54
WATERPROOF**

- Meet DIN878
- IP54 dust/waterproof
- With limit pointers
- Optional accessory: backs (page 167~168), contact points (page 164~166)



2324-10A

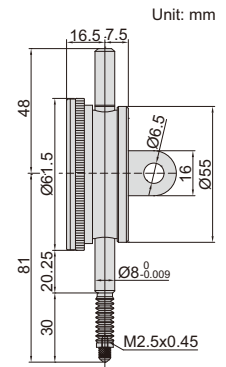

Code	Range	Graduation	Accuracy	Hysteresis	Range/rev	Dial reading	Remark
2324-10FA*	10mm	0.01mm	17µm	3µm	1mm	0-100	flat back
2324-10A*	10mm	0.01mm	17µm	3µm	1mm	0-100	lug back

*Supplied with manufacturer inspection certificate traceable to NIST USA

DOUBLE FACE DIAL INDICATOR

**INSPECTION
CERTIFICATE**
TRACEABLE TO NIST

- Meet DIN878
- Read from both sides
- Jeweled bearing
- Supplied with limit pointers
- Optional accessory: contact points (page 164~166)



front

back

2328-10

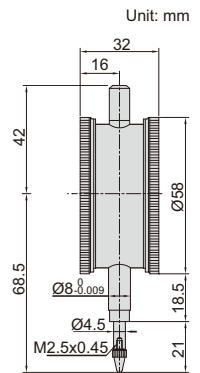

Code	Range	Graduation	Accuracy	Hysteresis	Range/rev	Dial reading
2328-10*	10mm	0.01mm	17µm	3µm	1mm	0-100

*Supplied with manufacturer inspection certificate traceable to NIST USA

DIAL INDICATORS (LONG STROKE)

**INSPECTION
CERTIFICATE**
TRACEABLE TO NIST

- Supplied with limit pointers and bezel clamp
- Optional accessory: backs (page 167~168), contact points (page 164~166)



2310-30A

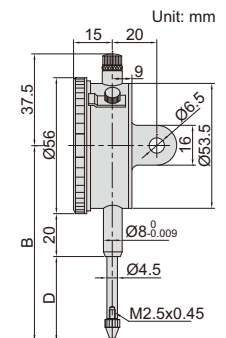

Code	Range	Graduation	Accuracy	Hysteresis	Range/rev	Dial reading	Remark	B (mm)	D (mm)
2310-20FA*	20mm	0.01mm	25µm	5µm	1mm	0-100	flat back	83	35
2310-30FA*	30mm	0.01mm	35µm	7µm	1mm	0-100	flat back	88	40
2310-20A*	20mm	0.01mm	25µm	5µm	1mm	0-100	lug back	83	35
2310-30A*	30mm	0.01mm	35µm	7µm	1mm	0-100	lug back	88	40

*Supplied with manufacturer inspection certificate traceable to NIST USA



DIAL INDICATORS (LONG STROKE, BASIC TYPE)

- Supplied with limit pointers and bezel clamp
- Packed in carton box
- Optional accessory: backs (page 167~168), contact points (page 164~166)



2302-25

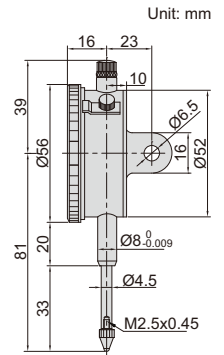

Code	Range	Graduation	Accuracy	Hysteresis	Range/rev	Dial reading	Remark
2302-25F *	25mm	0.01mm	35µm	7µm	1mm	0-100	flat back
2302-25 *	25mm	0.01mm	35µm	7µm	1mm	0-100	lug back with spare flat back

* Supplied with manufacturer inspection certificate traceable to NIST USA

DIAL INDICATORS (GRADUATION 0.1mm)

- Supplied with limit pointers and bezel clamp
- Optional accessory: backs (page 167~168), contact points (page 164~166)



2318-30

(mm)

Code	Range	Graduation	Accuracy	Hysteresis	Range/rev	Dial reading	Remark	B	D
2318-10F	10mm	0.1mm	40µm	20µm	10mm	0-10	flat back	70	20
2318-20F	20mm	0.1mm	50µm	20µm	10mm	0-10	flat back	85	35
2318-25F	25mm	0.1mm	60µm	20µm	10mm	0-10	flat back	85	35
2318-30F	30mm	0.1mm	60µm	20µm	10mm	0-10	flat back	90	40
2318-10	10mm	0.1mm	40µm	20µm	10mm	0-10	lug back	70	20
2318-20	20mm	0.1mm	50µm	20µm	10mm	0-10	lug back	85	35
2318-25	25mm	0.1mm	60µm	20µm	10mm	0-10	lug back	85	35
2318-30	30mm	0.1mm	60µm	20µm	10mm	0-10	lug back	90	40

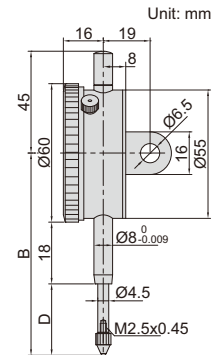

ONE REVOLUTION DIAL INDICATORS

- Meet DIN878
- Eliminate the possibility of reading errors due to miscounting
- Shockproof
- Supplied with limit pointers
- Optional accessory: backs (page 167~168), contact points (page 164~166)



2316-05

Code	Range	Dial indicator stroke	Graduation	Accuracy	Hysteresis	Dial reading	Remark
2316-05F *	0.5mm	5mm	0.01mm	9µm	3µm	25-0-25	flat back
2316-1F *	1mm	5mm	0.01mm	9µm	3µm	50-0-50	flat back
2316-05 *	0.5mm	5mm	0.01mm	9µm	3µm	25-0-25	lug back
2316-1 *	1mm	5mm	0.01mm	9µm	3µm	50-0-50	lug back

* Supplied with manufacturer inspection certificate traceable to NIST USA

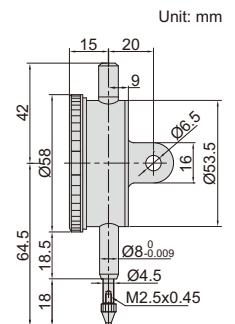

DIAL INDICATORS (LONG STROKE)

INSPECTION CERTIFICATE
TRACEABLE TO NIST

JEWELLED BEARING

SHOCK PROOF

- Shockproof
- Jewelled bearing
- Supplied with limit pointers
- Optional accessory: backs (page 167~168), contact points (page 164~166)



2309-50

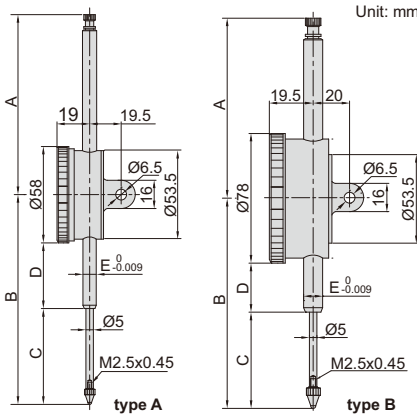

stem clamp Ø10mm for 2309-100D



back of type B



Code	Type	A	B	C	D	E
2309-30F	A	37.5	89.5	40.9	19.5	Ø8
2309-30	A	37.5	89.5	40.9	19.5	Ø8
2309-50	A	108.3	126.2	57.7	39.5	Ø8
2309-50D	B	108.3	126.2	57.7	29.5	Ø8
2309-80	A	138.4	168.4	88	51.3	Ø8
2309-80D	B	138.4	168.4	88	41.3	Ø8
2309-100D	B	167.6	207.8	108	60.8	Ø10

Code	Range	Graduation	Type	Accuracy	Hysteresis	Range/rev	Dial reading	Remark
2309-30F *	30mm	0.01mm	A	35µm	7µm	1mm	0-100	flat back
2309-30 *	30mm	0.01mm	A	35µm	7µm	1mm	0-100	lug back
2309-50 *	50mm	0.01mm	A	40µm	8µm	1mm	0-100	flat back with spare lug back
2309-50D *	50mm	0.01mm	B	40µm	8µm	1mm	0-100	flat back with spare lug back
2309-80	80mm	0.01mm	A	50µm	9µm	1mm	0-100	flat back with spare lug back
2309-80D	80mm	0.01mm	B	50µm	9µm	1mm	0-100	flat back with spare lug back
2309-100D	100mm	0.01mm	B	50µm	9µm	1mm	0-100	flat back with spare lug back

- Note: 1) 2309-80, 2309-80D and 2309-100D can only be used vertically
 2) 2309-100D is supplied with stem clamp Ø10mm for magnetic stands (code 6200-60, 6201-60, 6202-80, 6202-100)
 3) 2309-30 and 2309-30F can not accept optional backs (page 167~168)

* Supplied with manufacturer inspection certificate traceable to NIST USA

INCH LONG STROKE DIAL INDICATORS

INSPECTION CERTIFICATE
TRACEABLE TO NIST

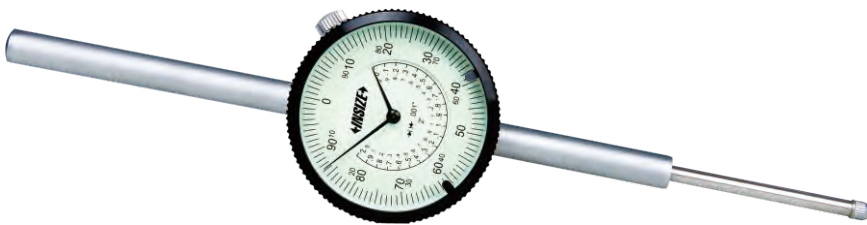

2326-2

- Graduation 0.001"
- With lug back
- Supplied with limit pointers and bezel clamp

Code	Range	Accuracy		Range/rev	Dial reading
		First 2.5 rev	Overall		
2326-2 *	2"	±0.001"	±0.004"	0.1"	0-100
2326-3 **	3"	±0.001"	±0.005"	0.1"	0-100
2326-4 **	4"	±0.001"	±0.005"	0.1"	0-100

* Supplied with manufacturer inspection certificate traceable to NIST

** 2326-3 and 2326-4 can only be used vertically

